

# SilverMax<sup>®</sup> Datasheet

**NEMA 17 Servomotors**

**OBSOLETE**

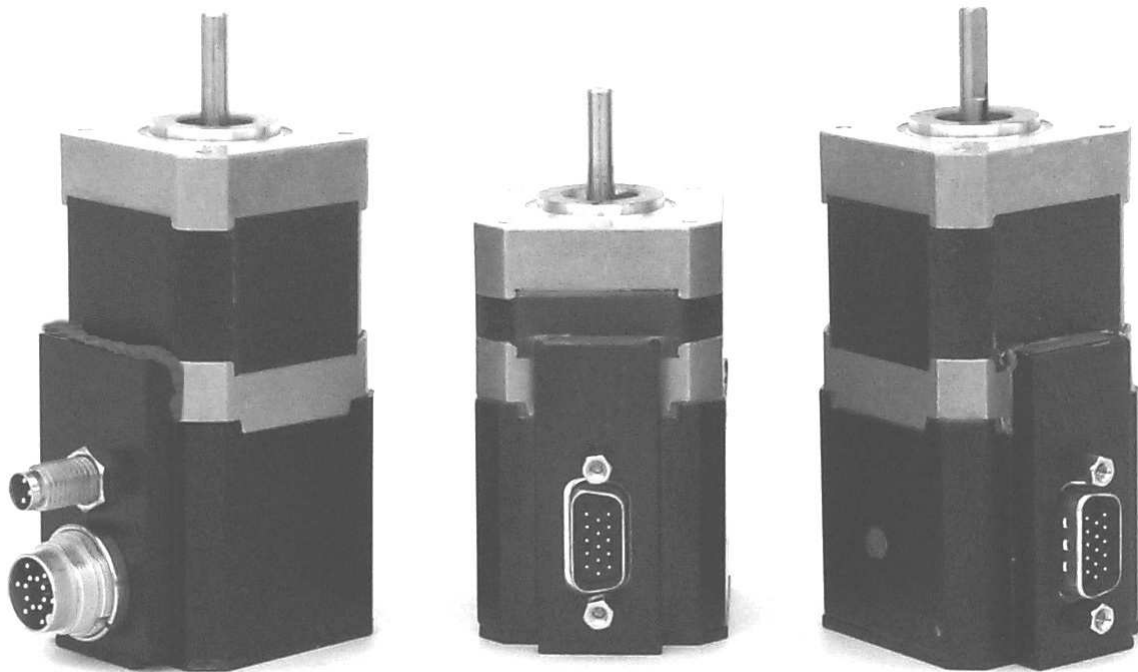

QuickSilver Controls, Inc.  
[www.quicksilvercontrols.com](http://www.quicksilvercontrols.com)

# SilverMax® Datasheet - NEMA 17 Servomotors

17 Frame Sizes: 17-1, 17-3, 17H-1, 17H-3 / Series: E, E3, E4 / Options: 01, 6T

All data presented in this document is recognized to be free of errors and subject to change without notice.

## Table of Operational Specifications

Specification	units	17 - 1	17 - 3	17H - 1	17H - 3
Maximum Speed	rpm	2500	2500	4000	4000
Continuous Stall Torque <sup>1</sup>	oz-in	21	36	23	43
Peak Power Output	watts <sub>(mech)</sub>	16	24	34	69
Optimal Speed <sup>2</sup>	rpm	1500	1500	2500	2500
Torque at Optimal Speed	oz-in	12	19	16	30
Rotor Inertia	oz-in <sup>2</sup>	0.19	0.37	0.19	0.37
Weight	ounces	9.5	14.3	9.5	14.3
Body Length (not incl. shaft)	inches	2.74	3.29	2.74	3.29
IP65 (6T) Body Length <sup>3</sup>	inches	2.94	3.49	2.94	3.49
Maximum Drive Current <sup>4</sup>	amps	1.3	1.5	3.0	4.0
Operating Voltage <sup>5</sup>	DC volts	+ 12 to + 48 (regulated)			
Safety Standards		UL, C-UL, CE (72/23/EEC)			

Specifications listed in table are at + 48 VDC operation.

<sup>1</sup> Torque ratings are dependent upon application duty cycle, ambient temperature and airflow present in application. Therefore, continuous operation at 100% torque levels is determined by these factors. 100% refers to torque levels set in QuickControl by the same nomenclature.

<sup>2</sup> Optimal Speed is a defined velocity where SilverMax is running at peak efficiency providing the best “power” performance. At or near this given speed, SilverMax will output near maximum mechanical power and run at the lowest temperatures. The highest duty cycle of continuous operation will be found at this optimal speed.

<sup>3</sup> SilverMax 17 frame servomotors with the 6T option are designed for IP65 rated applications. The 6T models are longer than standard servos to accommodate the two IP65 rated connectors for power & control signals.

<sup>4</sup> Maximum current draw occurs when SilverMax Torque Limits are set to “Max” and the driven load is equal to or greater than the maximum output torque of the servomotor.

<sup>5</sup> Each servomotor must be initialized for the selected operating voltage. Regulated supply 10% tolerance max.

### SilverMax Series Descriptions

#### E type includes the following:

- 7 I/O lines: input/output programmable, lines 4 thru 7 setup as 0 to +5 VDC analog inputs
- Selectable RS-232/RS-485 communications
- Selectable 8 bit ASCII or 9 bit binary protocols
- 8K byte internal nonvolatile memory
- 400 byte program execution buffer
- 4000 count encoder resolution

#### E3 adds the following to E type:

- 8000 count encoder resolution
- 32K byte internal nonvolatile memory

#### E4 adds the following to E type:

- Driver enable line (allocates I/O line 3)

### SilverMax Option Descriptions

#### 01 - Standard (one DB-15 connector)

- DB-15 high density connector

#### 6T - IP65 (two threaded round connectors)

- 14 pin IP65 rated signal connector
- 3 pin IP65 rated power connector
- Shaft seal kit is NOT included

IP65 rating is for body only and requires correctly tightened IP65 connectors. A shaft seal is required for IP65 rating on shaft (part no.: QCI-17M-65).

For specific details, see the Tech Support area of the QCI website or contact QCI Product Support directly. ([support@quicksilvercontrols.com](mailto:support@quicksilvercontrols.com))

# SilverMax<sup>®</sup> 17 Frame Mechanical Data

Mechanical drawing files in CAD formats are available for download from the QCI website. All measurements are in inches (Tolerance is +/- 0.01" or as designated).

## Standard SilverMax Option ( 01 )

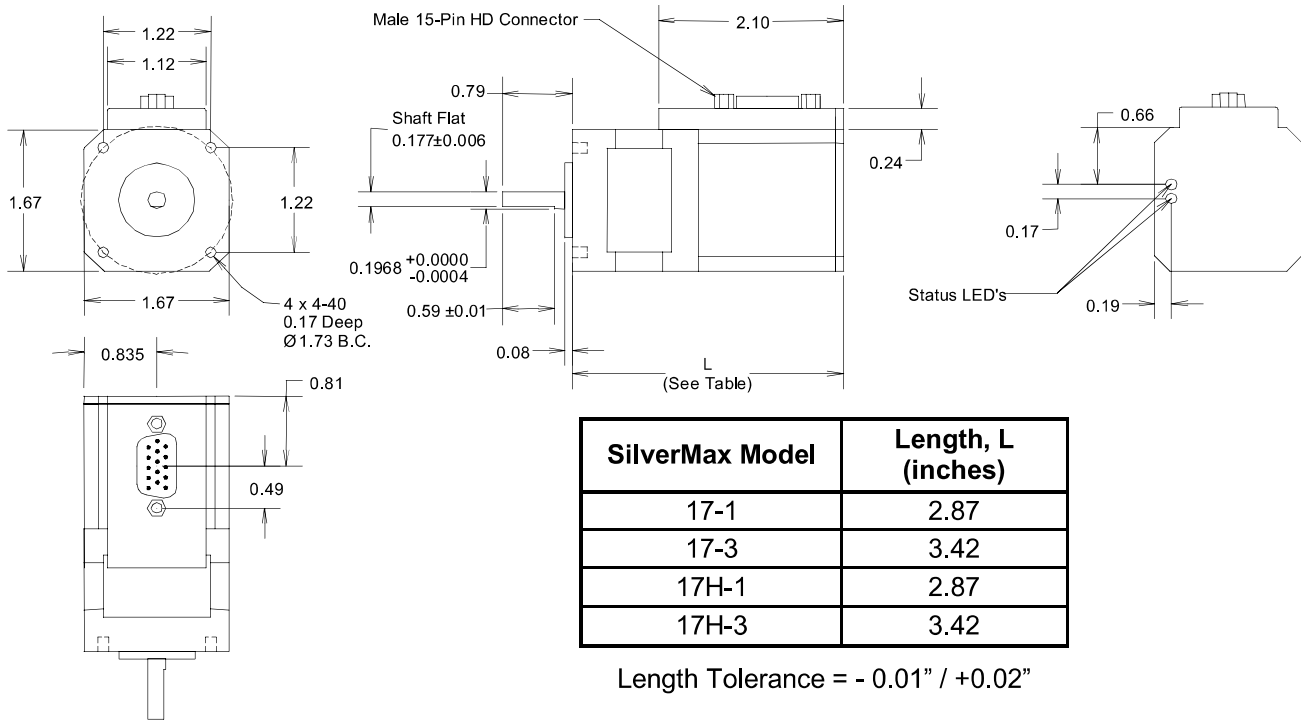

## IP65 SilverMax Option ( 6T )

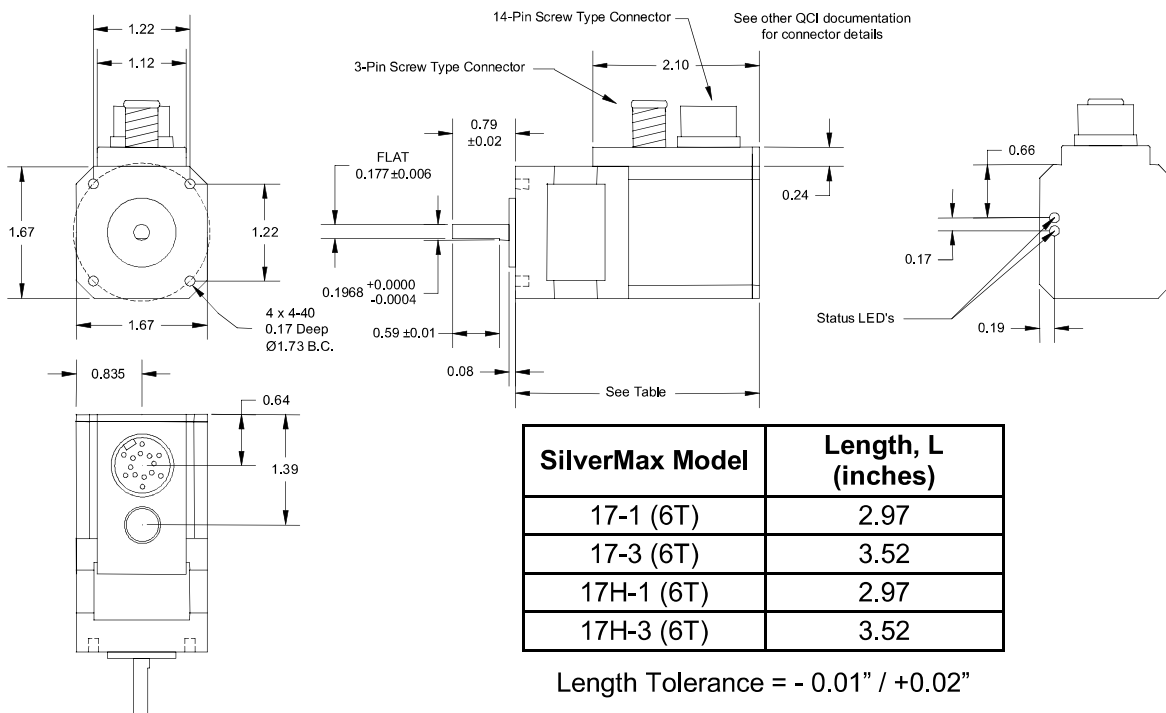

## SilverMax<sup>®</sup> 17 Frame Connection Data

Standard SilverMax 17 and 17H servomotors (01 option) are designed with one connector, a 15-pin high density D-sub (DB-15) for all control signals and input power connections. The “6T” option utilizes two round twist (or screw) type connectors in place of the DB-15 connector.

### Connector for Standard SilverMax Option ( 01 )

On 17 frame servomotors, the DB-15 connector permits access to I/O signals, serial communications, controller/drive power inputs, and ground lines. It is designed to connect to all DB-15 based SilverMax cables (SMI) for easy connection to most QCI accessory products.

### Technical Details of the DB-15 Connector ( 01 )

Servomotor Connector:	15-pin high density D-subminiature, pins in a plug type gender.
Cable Connector:	15-pin high density D-subminiature, holes in a socket type gender.
Cabling:	26 AWG for I/O & Com signals, 20 AWG for +V Power & Power
Contacts:	Crimp type rated at 5 amps per contact (recommended).
Shell Type:	Same as a standard DB-9.

DB-15 Pin Layout - Top View on SilverMax

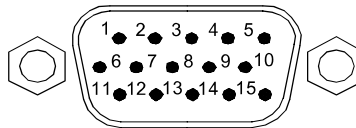

Pin #	Signal	Pin #	Signal
1	+V DC Input Power	9	I/O Line 2
2	RS-232 Tx / RS-485 A	10	I/O Line 5
3	+5 VDC Output (100 mA Supply)	11	Power Ground (Input)
4	** I/O Line 3 (E4 option)	12	RS-232 Rx / RS-485 B
5	I/O Line 6	13	I/O Line 1
6	Power Ground (Input)	14	I/O Line 4
7	+V DC Input Power	15	I/O Line 7
8	Logic Ground (I/O & Serial Com)	Shell	Chassis Ground

### Signal Notes:

- +V Input Power & Power Ground are NOT reverse polarity protected. (+V = 1 & 7, Gnd = 6 & 11).
- Logic ground (pin 8) is utilized for all direct I/O functions and serial communications to ensure proper signal level control.
- I/O lines 1, 2, and 3 each have an internal 4.7k ohm pull-up resistor connected to the +5 V supply.
- I/O lines 4 thru 7 each have an internal 200k ohm effective impedance connection to the +5 V supply.
- \*\* E4 Drive Enable Option: On 17 frame servos, I/O line 3 (pin 4) is allocated for the Drive Enable signal. The input line has a 4.7k ohm pull-down resistor connected to logic ground. An active high signal is required to enable the servomotor drive.
- +5 V DC supply outputs (pin 3) of multiple servos should not be connected together on a common bus.

## Connectors for IP65 SilverMax Option ( 6T )

The two round screw type connectors designed into the “6T” option separate power inputs from control signals. The 3-pin connector is for input power and the 14-pin connector is for control signals. These rugged IP65 rated connectors provide secure connections to SilverMax in wash down or other industrial applications. QCI cabling provides flying leads on the opposite end of the 3-pin power connector and a DB-15 connector on the end opposite the 14-pin round connector. The 6T signal cables are designed for easy connection from SilverMax to most QCI accessory products.

### 14-Pin Signal Connector

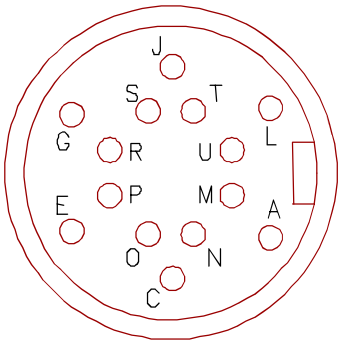

Pin #	Signal	Pin #	Signal
A	I/O Line 6	N	I/O Line 4
C	Logic Ground / Shield	O	I/O Line 2
E	Logic Ground	P	I/O Line 1
G	+5 VDC Output (100 mA Supply)	R	RS-232 Rx / RS-485 B
J	* NC	S	RS-232 Tx / RS-485 A
L	I/O Line 7	T	* NC
M	I/O Line 5	U	** I/O Line 3 (E4 option)

### 3-Pin Power Connector

Pin #	Signal
1	Power Ground (Input)
2	Chassis Ground
3	+V DC Input Power

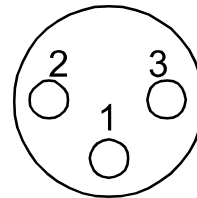

### Signal Notes:

- +V Input Power & Power Ground are NOT reverse polarity protected. (+V = Pin 3, Gnd = Pin 1).
- Logic ground (pin C & E) is needed for all direct I/O functions and serial communications to ensure proper signal level control.
- I/O lines 1, 2, and 3 each have an internal 4.7k ohm pull-up resistor connected to the +5 V supply.
- I/O lines 4 thru 7 each have an internal 200k ohm effective impedance connection to the +5 V supply.
- \*\* E4 Drive Enable Option: On 17 frame servos with the E4 option, I/O line 3 (pin U) is allocated for the Drive Enable signal. The input line has a 4.7k ohm pull-down resistor connected to logic ground. An active high signal (+5 VDC) is required to enable the servo drive.
- +5 VDC supply outputs (pin G) of multiple servos should not be connected together on a common bus.
- \* NC is defined as a “No Connect” on the 17 frame SilverMax connector only. The 14-pin 6T signal cable has all 14 contacts wired through the cable.

# Performance Data

NOTE: Torque data is not for continuous operation, unless the internal temperature sensed by SilverMax remains below +80C. Lower ambient temperatures result in lower SilverMax temperatures. It has been determined that a small amount of airflow across the servomotor greatly reduces the SilverMax temperature.

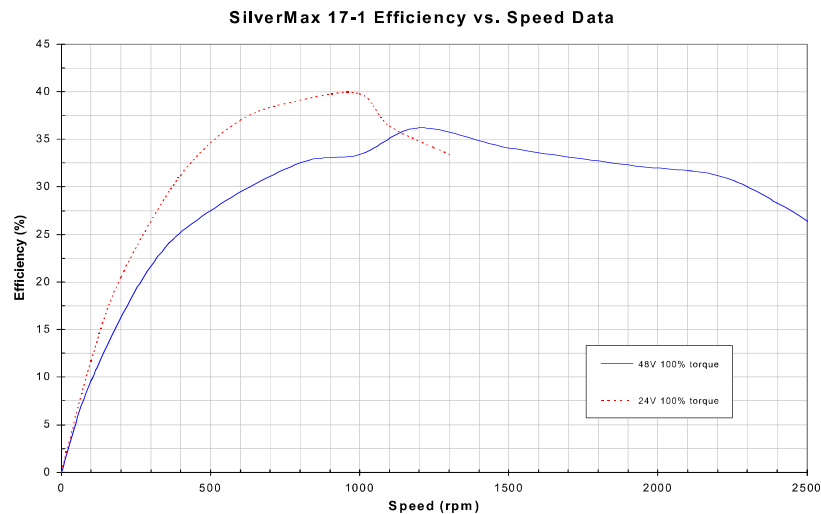
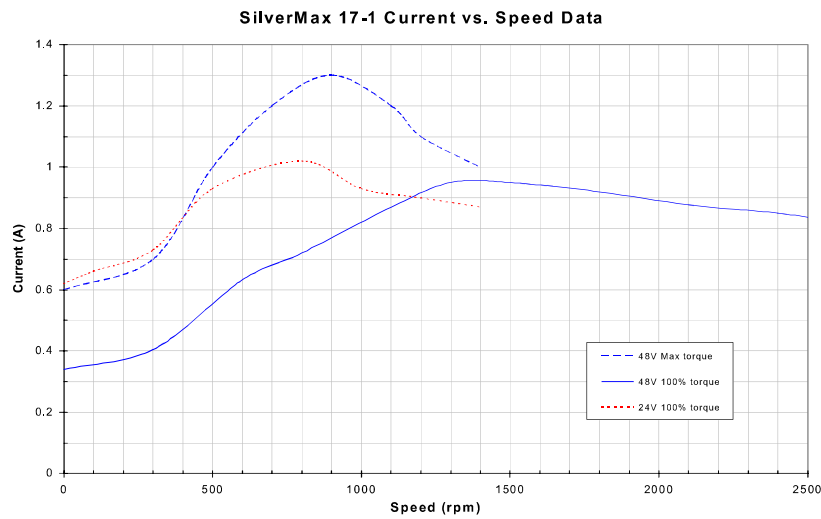
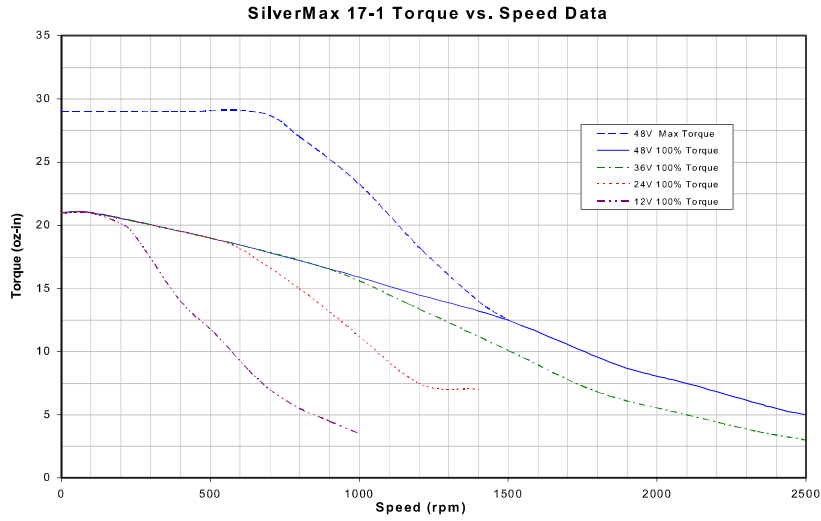

**SilverMax 17-3 Torque vs. Speed Data**

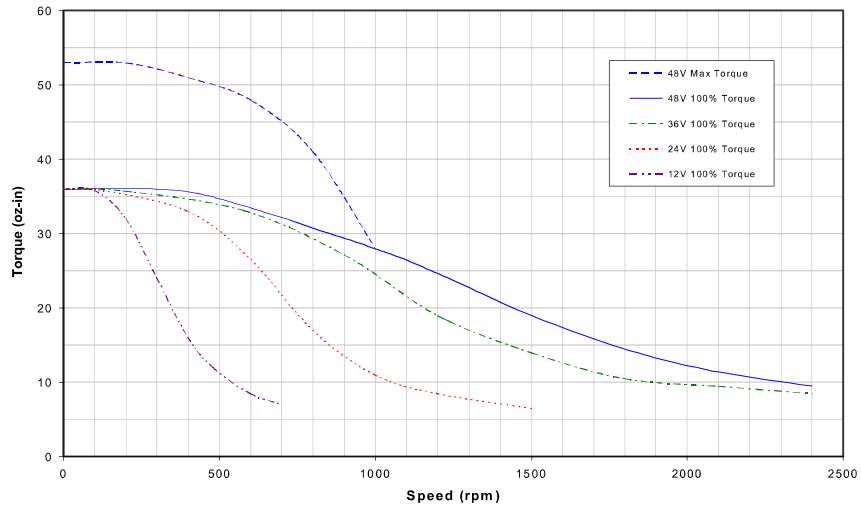

**SilverMax 17-3 Current vs. Speed Data**

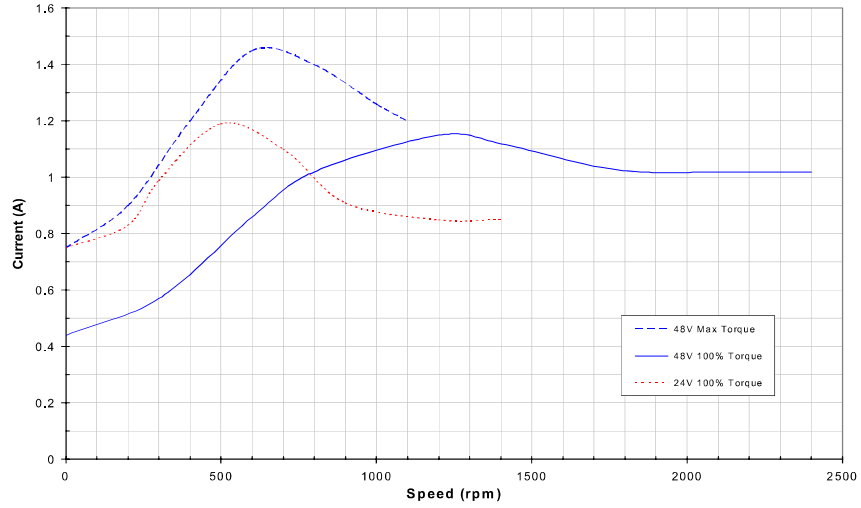

**SilverMax 17-3 Efficiency vs. Speed Data**

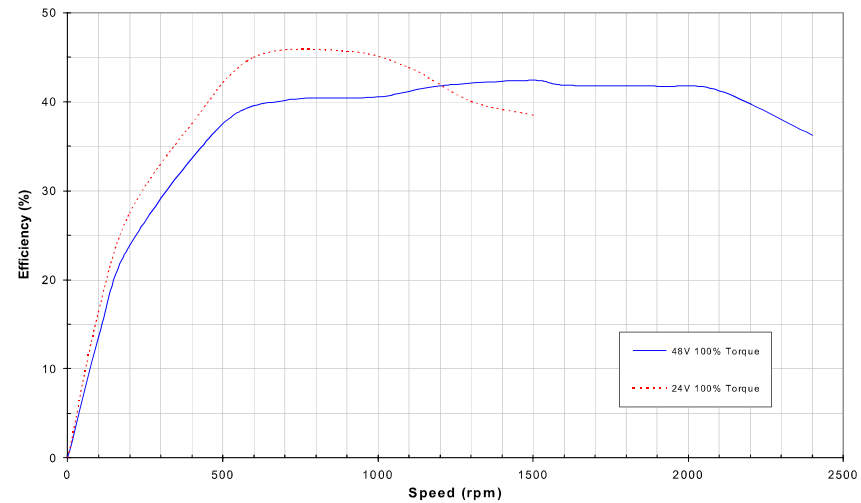

**SilverMax 17H-1 Torque vs. Speed Data**

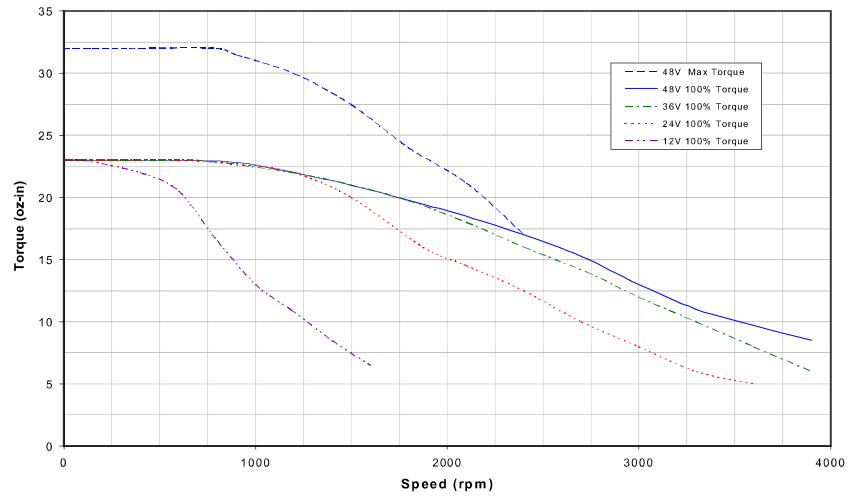

**SilverMax 17H-1 Current vs. Speed Data**

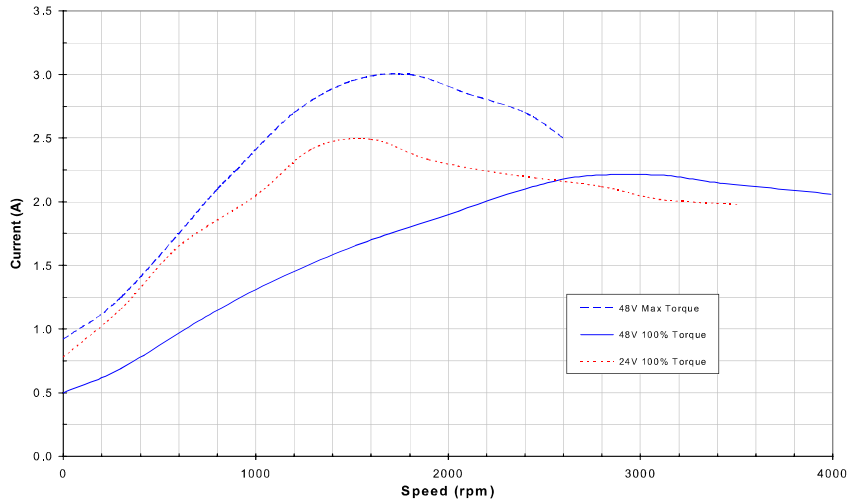

**SilverMax 17H-1 Efficiency vs. Speed Data**

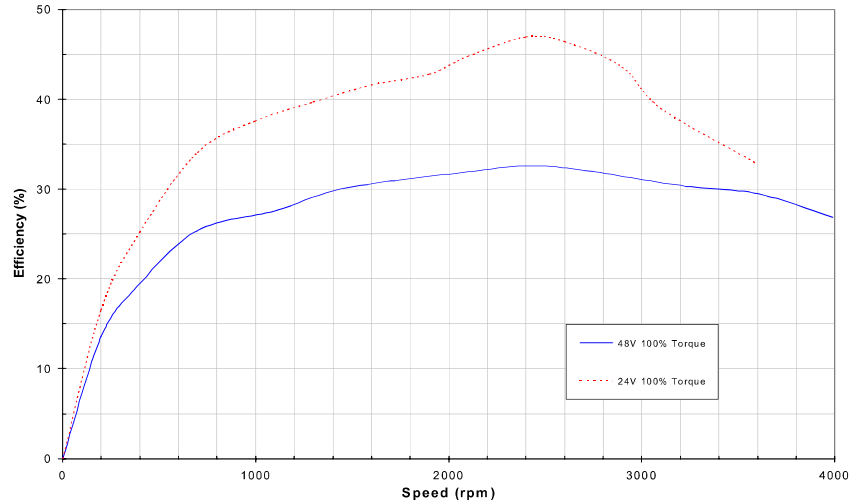



**SilverMax 17H-3 Torque vs. Speed Data**

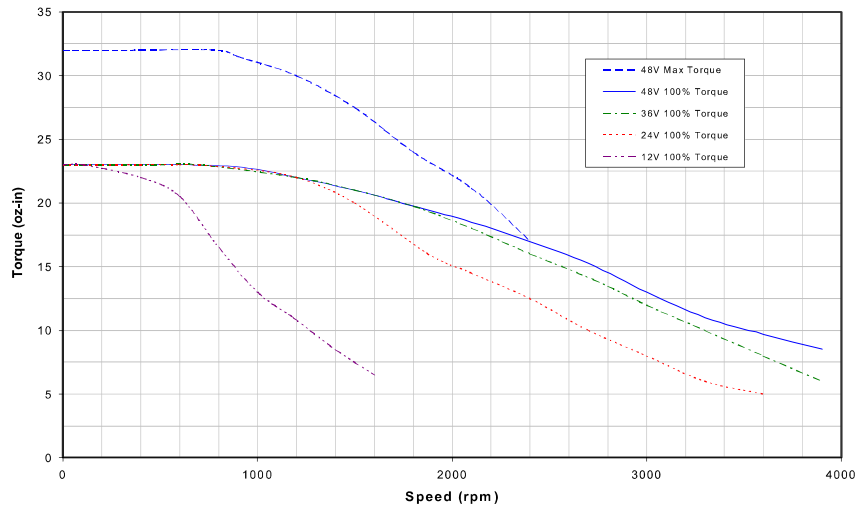

**SilverMax 17H-3 Current vs. Speed Data**

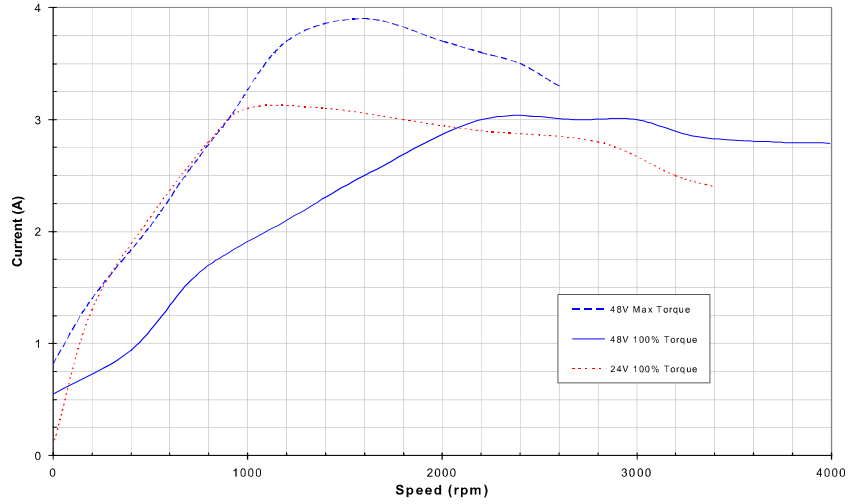

**SilverMax 17H-3 Efficiency vs. Speed Data**

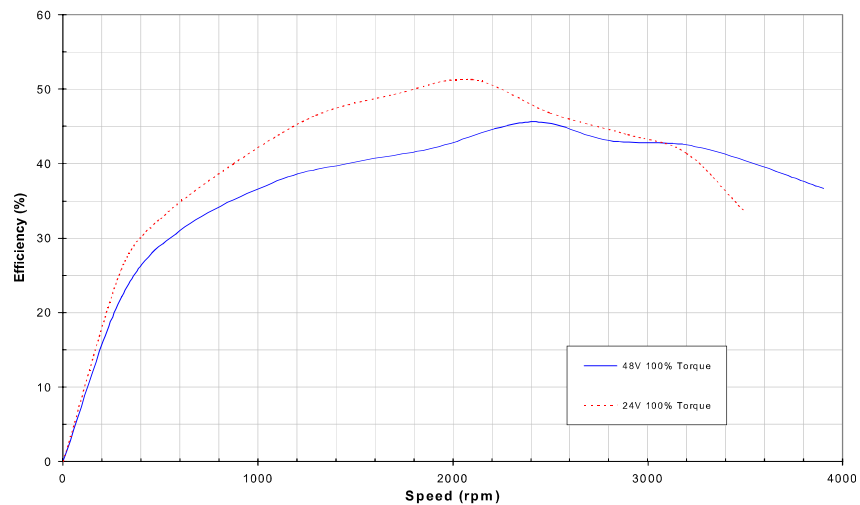

## Servomotor Specifications

### Supply Power (Input)

**Voltage:** + 12 VDC to + 48 VDC operation range for servo drive. Regulated source required, 10% max. tolerance. Each servomotor must be initialized for the selected operating voltage. Servo drive disables when supply voltage falls below +10.5 VDC. See SilverMax User Manual (rev. 4.0+) for details.

**Current:** Current data is application specific for SilverMax drive types. See the Specifications Table and the Performance Data charts provided in this datasheet for specific current requirements.

**Controller Power:** + 7.5 VDC to + 48VDC (reg. 10% max. tol.). Control electronics (DSP, encoder, communications, I/O, etc.) requires approx. 2.5W of power to operate. (Note the drive is disabled when the supply voltage falls below +10.5 VDC.)

**Over-Voltage Protection:** None available. Voltages exceeding +55 VDC will permanently damage the integrated electronics. Supply inputs may require active voltage clamping for applications with high inertial loads or rapid deceleration/braking.

**Reverse Polarity Protection:** None available. Connecting the supply voltage in reverse will damage the servomotor.

**+5 VDC Supply Output:** A low current TTL level +5V power source is available from every SilverMax. It has a maximum current capacity of ~100mA. It should not be connected in serial or parallel circuits with other +5 VDC voltage sources, specifically other SilverMax.

### Inputs and Outputs (+5 VDC Control Signals)

**Digital Inputs:** TTL level only. All inputs operate on 0 V or +5 V signals (active low / sinking). Inputs 1, 2 and, 3 have internal 4.7K ohm pull-up resistors to the +5 V. Inputs 4, 5, 6, and 7 have effective internal 200K ohm impedance to +5 V.

**Digital Outputs:** TTL level only. 0 V or +5 V.  $\pm 5$  milliamps (sinking or sourcing).

**I/O Over-voltage Protection:** Each I/O line is double protected with parallel MOV clamping devices followed by series over-voltage limiting.

### Encoder Inputs & Outputs

**Signal Levels:** 0 VDC to +5 VDC. TTL level only.

**Compatible Signal Type:** A-B-I (quadrature), Step-Direction (pulses-bit), and Step Up-Step Down.

**Maximum Bandwidth:** 1 MHz per input channel.

### Analog Inputs

Analog input channels (software) 1, 2, 3, & 4 map to I/O lines (hardware) 4, 5, 6, & 7 respectively. Each input has effective internal 200k-ohm pull-up impedance to +5 VDC. Additional analog inputs available for +V power bus, processor +V power, and internal temperature.

**Input signal range:** 0 VDC to +5 VDC

**Resolution:** 10 bit (single input) or 11 bit (differential input).

**Sampling:** Analog input signals are captured and converted every servo cycle (120 usec.). The converted data is processed via a 5 ms filter to reduce noise and transients. The filtered data output is updated every 120 usec.

## Communications

### Hardware Interfaces:

RS-232 serial, RS-232 serial multi-drop & RS-485 serial network (software selectable, std. firmware).

### Hardware Configuration Settings

Baud Rates (software selectable)	4800, 9600, 19.2k, 28.8k, 57.6k, 115.2k, or 230.4k
Data Bits	8
Stop Bits	1.5 or 2
Parity Bit	None

**Protocols:** 8-bit ASCII or 9-bit binary (software selectable). Modbus RTU (firmware upgrade required).

**Communication Line Protection:** Each com line is protected with parallel MOV clamping devices. (Nominal 25k ohm resistance to logic ground.)

## Servo Control Specifications

### Encoding Resolution (Internal):

4000 counts/rev. (0.09 deg./count): Standard on all 17 and 17H servos.

8000 counts/rev. (0.045 deg./count): Optional for 17 and 17H servos (E4 option).

**Servo Cycle Rate:** 120 microseconds = 8.33 kHz

**Software Torque Control:** Signed 16 bit control: 1 part in 32767

**Internal Memory** (\* Standard on all 17 and 17H servomotors.)

Serial Communications Buffer	10 words (20 bytes)*
Program Buffer	200 words (400 bytes)*
Non-Volatile Memory (Std. E option)	8K bytes (4K words)*
Non-Volatile Memory (E3 option only)	32K bytes (16K words)

**Processor:** 20 MHz Digital Signal Processor (TI TMS series), 32-bit digital servo processing.

## Environmental Specifications

### Temperature Specifications

Operating (electronics section)		Operating (winding section)	Storage	
Min.	Max.	Max.	Min.	Max.
-10 C	+80 C	+105 C	- 40 C	+85 C

NOTE: Operating SilverMax in environments having temperatures outside this range is possible if the electronics section is kept above -10C and below +80C during motion.

**Humidity:** Continuous specification is 95% RH non-condensing.

**Shock:** Limitation is approximately 50g/11ms.